

VNH12-55W-F1

12V 55 W/Cell 15min (14Ah / 20h)**BATTERY**
Samson

Introduction

Samson VNH (high rate) series is primarily for heavy load discharge in short time backup especially in UPS applications. Designed with a high-density plate technology, the series battery is featured of high consistency, excellent performance and reliable standby service life.

Battery Features

- High rate output aimed at the UPS market
- Low self-discharge
- Fully tank formed plates
- Low impurity electrolyte
- Spill proof / leak proof
- Multi-position usage
- ABS case and cover VO upon request
- Very high purity lead

Electrical Specification

Design floating Life @ 25°C (77°F)	5 years
------------------------------------	---------

Design Life Cycles @ 50% D.O.D. (25°C)	600 Cycles
----------------------------------------	------------

Nominal Capacity @ 25°C /77°F

20 hour rate 0.7 A to 1.75V/cell	14 Ah
Watt @ 15min to 1.67V/cell	55 W/cell
Watt @ 10min to 1.67V/cell	72 W/cell

Internal Resistance

(Fully charged battery @ 25°C /77°F)	12mΩ
--------------------------------------	------

Max. Discharge Current @ 25°C /77°F	140A (5S)
-------------------------------------	-----------

Short Circuit Current	220 A
-----------------------	-------

Charge Methods: Constant voltage charge @ 25°C /77°F

Cycle Use	14.7 ~ 14.9V
Max. Current	3.0A
Max. Current for best battery life	3.0 A
Standby Use	13.6 - 13.8V

Operating Temperature Range	-30 ~ 50°C
-----------------------------	------------

Notes: battery voltage must be adjusted according to temperature.

Effect of temperature on float charge voltage: $-3mV/ ^\circ C /Cell$.

Self-Discharge

3% of capacity declined per month @ 25°C (77°F).

Typical Applications

- UPS/EPS (High rate)
- Emergency lighting
- High power backup supply
- Electric starting
- Emergency power supply

Certificates



Battery Picture & Terminal Layout

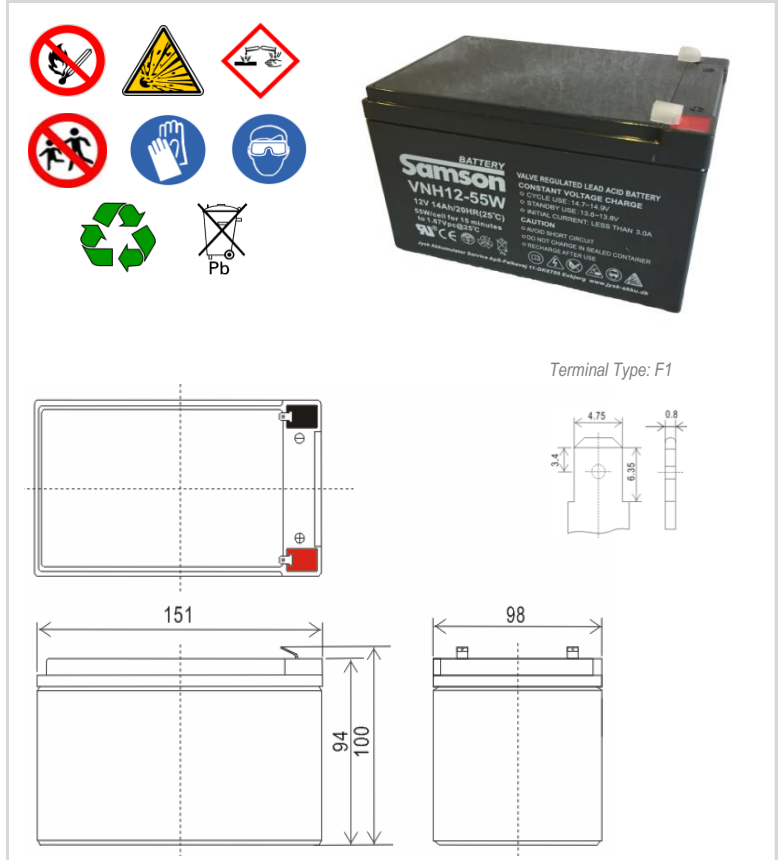

Dimension & Weight

Length	Dimension (± 2mm)			Total Height	Weight (± 2%)
	Width	Height	Total Height		
151 mm	98 mm	94 mm	100 mm	3,77 kg	
5,9 inch	3,9 inch	3,7 inch	3,9 inch	8,3 lbs	

Constant Current Discharge (Amperes @ 25°C /77°F)

V/cell	3min	5min	10min	15min	20min	30min	45min	1hr	2hr
1,60	71,05	62,05	37,01	27,86	22,61	16,74	12,55	10,37	5,59
1,65	70,67	59,67	35,73	27,71	22,18	16,58	12,54	10,27	5,58
1,70	69,57	58,39	35,12	27,28	22,15	16,48	12,51	10,23	5,54
1,75	67,50	53,30	33,67	26,47	21,66	16,35	12,48	10,21	5,49
1,80	64,30	48,17	31,18	25,21	20,75	15,91	12,21	10,08	5,44

Constant Power Discharge (Watts/cell @ 25°C /77°F)

V/cell	3min	5min	10min	15min	20min	30min	45min	1hr	2hr
1,60	1,60	124,8	74,4	55,8	45,20	33,28	24,83	20,15	11,49
1,65	1,65	121,7	73,8	55,6	45,07	33,23	24,70	20,04	11,23
1,67	1,67	119,2	72,0	55,0	45,00	33,20	24,58	19,97	11,02
1,70	1,70	113,8	70,4	54,5	43,77	32,22	24,16	19,69	10,67
1,75	1,75	110,2	68,0	53,9	42,84	31,97	23,94	19,33	10,30
1,80	1,80	97,6	62,8	50,9	41,70	31,85	23,61	18,86	10,07

Above discharge data is average values after batteries are fully charged.

Other relevant information

Contry of origin:	China	HS Code (harmonized system code):	85 07 20 00
UN-Transport declaration:	UN2800	Customs tariff number	8507 10 20 80

Subject to revision without notice. Please contact our sales representatives for latest version.

Web: www.jysk-akku.dk

E-mail: jvba@jysk-akku.dk

Version No.: 23-04-2021

Page 1 of 2

VNH12-55W F1

12V 55 W/Cell 15min (14Ah / 20h)



Graphs

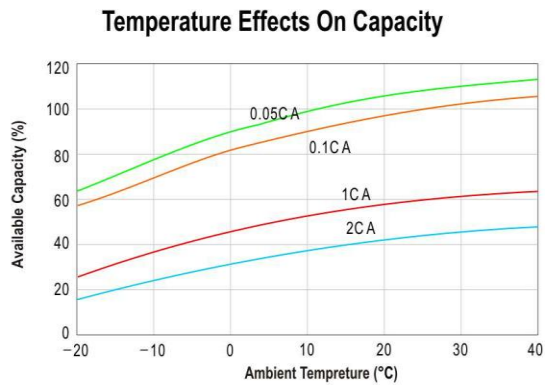
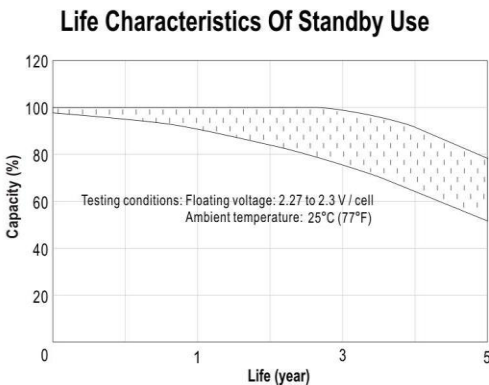
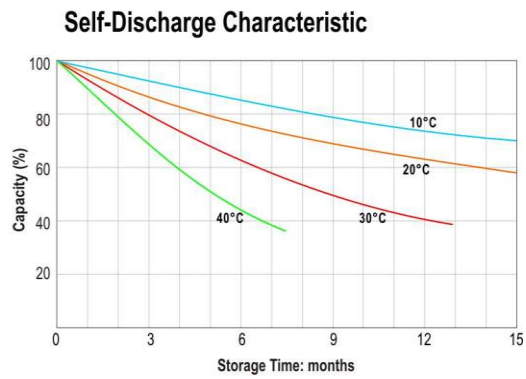
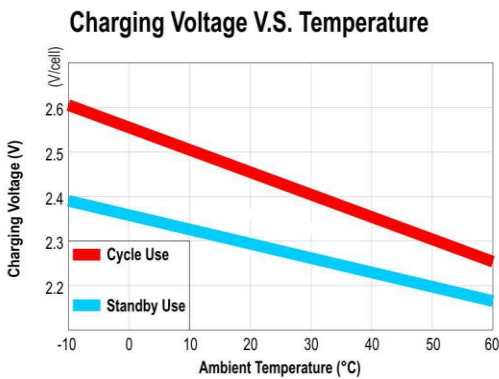
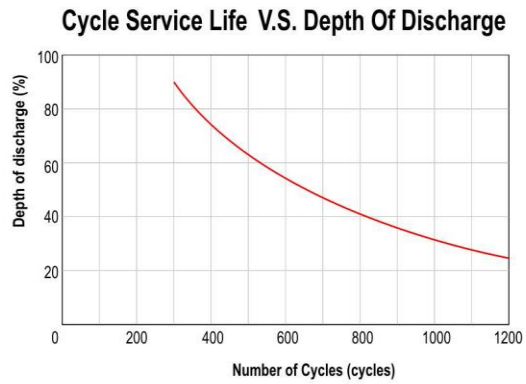
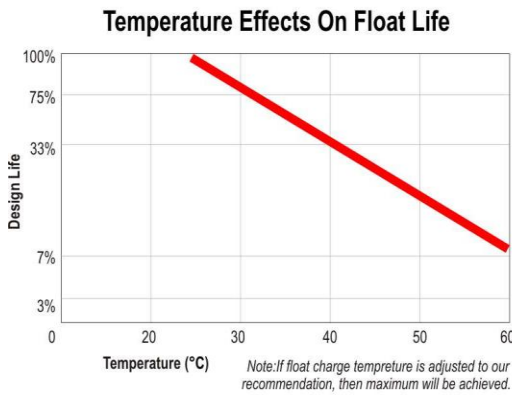
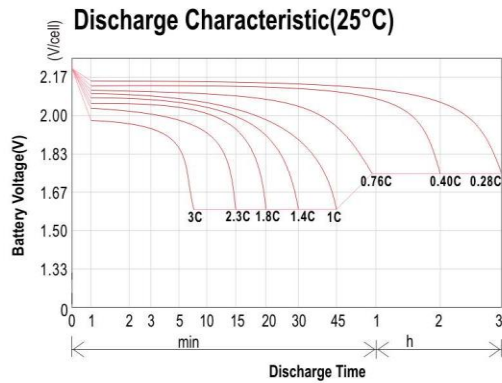
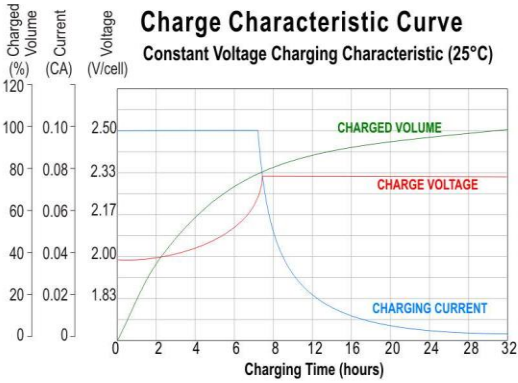

Subject to revision without notice. Please contact our sales representatives for latest version.